

SERVICE
MANUAL

PM230

marantz®

model PM230

Stereo Pre Main Amplifier

MARANTZ DESIGN AND SERVICE

Using superior design and selected high grade components, MARANTZ company has created the ultimate in stereo sound. Only **original MARANTZ parts** can insure that your MARANTZ product will continue to perform to the specifications for which it is famous.

Parts for your MARANTZ equipment are generally available to our National Marantz Subsidiary or Agent.

ORDERING PARTS:

Parts can be ordered either by mail or by telex. In both cases, MARANTZ part number has to be specified. If you order by mail, fulfil MARANTZ order forms.

MARANTZ S.A.
EUROPEAN PARTS DEPARTMENT
2, Avenue Léopold III
B-7120 PERONNES-lez-BINCHE
BELGIUM
TWX: 57589 SEPLT B

The following information must be supplied to eliminate delays in processing your order:

1. Complete address
2. Complete part numbers and quantities required
3. Description of parts
4. Model number for which part is required
5. Way of shipment
6. Signature: any order form or telex must be signed otherwise such part order will be considered as null and void.

PARTS ORDERING:

Parts may be ordered from the following addresses:

EUROPE

MARANTZ S.A.

European Parts Department
2, Avenue Léopold III
B-7120 Péronnes-lez-Binche
Belgium
Telex: 57589

MARANTZ NORSE A.S.

Refstadalleen 13
Oslo 5
Norway
Telex: 19659

MARANTZ DENMARK

Bregnerødvej 132b
3460 Birkerød
Denmark
Telex: 39137

MARANTZ GMBH AUSTRIA

Wiedner Hauptstrasse 98
1050 Wien
Austria
Telex: 113583

MARANTZ S.A.

326 Avenue Louise Bte 32
1050 Brussels
Belgium
Telex: 26602

MARANTZ FRANCE

4 Rue Bernard Palissy
92600 Asnières
France
Telex: 611651

MARANTZ BELGIUM

45 Rue Auguste Van Zande
1080 Brussels
Belgium

MARANTZ SVENSKA A.B.

Svartviksvangen 56
Traneberg - Box 12016
16112 Bromma
Sweden
Telex: 13449

MARANTZ GERMANY GMBH

Max Planckstrasse, 22
6072 DREIEICH 1
West Germany
Telex: 4185316

MARANTZ AUDIO U.K. LTD.

Unit 15/16
Saxon Way Industrial Estate
Moor Lane
Harmondsworth UB7 OLW
Great Britain
Telex: 935196

AUSTRALIA

MARANTZ AUSTRALIA PTY., LTD.

32 Cross Street
Brookvale, N.S.W. 2100
Australia
Telex: 24121

All of the above locations are fully equipped to take care of your total service needs. Because various countries have differing configuration requirements, it is necessary that you contact the service facility in your particular country. In the event that there is no service location listed for your country, please, contact the nearest facility for the necessary assistance.

In case of difficulties, do not hesitate to contact the Technical Department at abovementioned address.

marantz®

TABLE OF CONTENTS

SECTION	PAGE
INTRODUCTION	1
1. FUNCTION SWITCH	1
2. MAIN VOLUME	1
3. PREAMPLIFIER	1
4. MODE SWITCH CONTROLLER	1
5. POWER AMPLIFIER	2
6. SPEAKER	2
7. P.W. BOARDS	2
8. TEST EQUIPMENT REQUIRED FOR SERVICING	2
9. ADJUSTMENT PROCEDURES	2
10. VOLTAGE CONVERSION	3
11. BLOCK DIAGRAM	4
12. DIAGRAM AND COMPONENT LOCATIONS	5
12.1 Phono Amp./Input Terminal Assembly (P400) Schematic Diagram and Component Locations	5
12.2 Phone Jack Assembly (PW01) Schematic Diagram and Component Locations	5
12.3 Main Assembly (P700) Schematic Diagram and Component Locations	6
12.4 Main Volume Assembly (PS02) Schematic Diagram and Component Locations	6
12.5 Balance Volume Assembly (PG02) Schematic Diagram and Component Locations	6
12.6 Power Switch Assembly (PO01) Schematic Diagram and Component Locations	7
12.7 Speaker Terminal Assembly (PV00) Schematic Diagram and Component Locations	8
12.8 Tone Amp. Assembly (PE00) Schematic Diagram and Component Locations	9
12.9 Function Assembly (PX00) Schematic Diagram and Component Locations	9
12.10 Low Filter Loud. Assembly (PE02) Schematic Diagram and Component Locations	10
12.11 Tone Volume Assembly (PE01) Schematic Diagram and Component Locations	10
12.12 Tone Amp./Volume Control Assembly (PE03) Schematic Diagram and Component Locations	10
13. EXPLODED VIEW AND PARTS LIST	11
14. ELECTRICAL PARTS LIST	15
15. TECHNICAL SPECIFICATIONS	19
16. SCHEMATIC DIAGRAM	20

MODEL PM230 STEREO AMPLIFIER

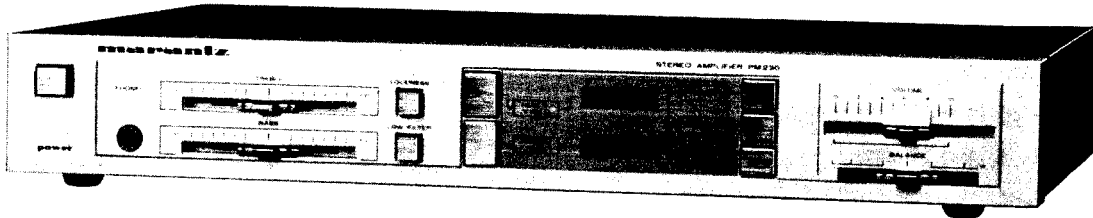

INTRODUCTION

This service manual was prepared for use by Authorized Warranty Stations and contains service information for the Marantz Model PM230 Stereo Console Amplifier.

Service information and voltage data included in this manual are intended for use by knowledgeable and experienced personnel only. All instructions should be read carefully. No attempt should be made to proceed without a good understanding of circuitry operation.

The parts list furnishes complete ordering information. Most replacement parts should be ordered from the Marantz Company. However, a simple description is included for parts which can be obtained locally.

1. FUNCTION SWITCH

The function switches control a high voltage (25 V) type switching IC (LC7185H) to select one of the four inputs and the tape monitor channel which is selected with the TAPE OUT/MONITOR switch. The TAPE OUT/MONITOR switch controls a high voltage-type switching IC (LC4066 BH).

The source which is selected when the power switch was turned off is automatically reselected when the power is turned on.

The signals from the AUX, TUNER and TAPE (1) input terminals are applied to electronic switch QS01. The signal from the PHONO input terminals are amplified (35 dB) and equalized by equalizer amplifier Q401, then applied to electronic switch QS01.

The signals from the TAPE (2) IN terminals are applied to electronic switch QS02, then applied to QS01.

2. MAIN VOLUME

A 100 k Ω (B curve) potentiometer is used for the main volume control and a 200 k Ω (W curve) potentiometer is used for the balance control.

3. PREAMPLIFIER

The first stage of the preamplifier uses op-amplifier NJM 4560DD (selected for internal noise) (QE01) and has a gain of about 20 dB. Loudness control elements are inserted in the NF circuit of this stage so that frequency response is increased by 6 dB at 100 Hz.

The second stage is an NF type tone control circuit using op-amplifier NJM4558D (QE02). The frequency response can be varied with slide type potentiometers as shown below.

TREBLE ± 10 dB at 10 kHz

BASS ± 10 dB at 100 Hz

4. MODE SWITCH CONTROLLER

The loudness control uses a slide switch with a stroke of 1.5 mm to control the loudness elements in stage 1 of the preamplifier.

The low filter circuit follows the 2nd stage of the pre-amplifier and has an attenuation of 3.0 dB at 50 Hz.

5. POWER AMPLIFIER

Hybrid IC STK-3042-IIA is used for the voltage amplifier, and the power amplifier stage uses discrete transistors. STK-3042-IIA is an improved version of STK-3042 and it shows good performance with pop noises. Thus, no muting relay is required for the PM230. The input stage of the power amplifier uses 2SD1302 (QK03 and QK04), which features low Vce saturation so that the output signal is muted when the function switch is operated or the power is turned on and off. (The gain is about 30 dB.)

6. SPEAKER

Only the "SYSTEM 1" speaker terminals can be used. The speakers are automatically disconnected when a headphone plug is inserted in the headphone jack.

7. P.W. BOARDS

As can be seen from the circuit diagram the chassis of Model PM230 consists of the following units. Each unit mounted on a printed circuit board is described within the square enclosed by a bold dotted line on the circuit diagram.

1. Phono Amp./
Input Terminal mounted on P.W. Board P400
2. Main mounted on P.W. Board P700
3. Tone Amp. mounted on P.W. Board PE00
4. Tone Volume mounted on P.W. Board PE01
5. Low Filter mounted on P.W. Board PE02
6. Tone Amp.
Volume Control mounted on P.W. Board PE03
7. Balance Volume mounted on P.W. Board PG02
8. Main Volume mounted on P.W. Board PS02
9. Power Switch mounted on P.W. Board PO01
10. Speaker Terminal mounted on P.W. Board PV00
11. Phone Jack mounted on P.W. Board PW01
12. Function mounted on P.W. Board PX00

8. TEST EQUIPMENT REQUIRED FOR SERVICING

This table lists the test equipment required for servicing the Model PM230 Stereo Pre Main Amplifier.

Item	Use
Distortion Analyzer	Distortion measurements
Audio Oscillator	Sinewave and squarewave signal source
AC VTVM	Voltage measurements (AC)
Oscilloscope	Waveform analysis and trouble shooting and ASO alignment
Circuit Tester	Trouble shooting
DC VTVM	Voltage measurements (DC)
AC Wattmeter	Monitors primary power to amplifier
Line Voltmeter	Monitors potential of primary power to amplifier
Variable Autotransformer (0 ~ 140V AC, 10A)	Adjust level of primery power to amplifier
Shorting Plug	Shorts amplifier input to eliminate noise pickup

9. ADJUSTMENT PROCEDURES

Idling adjustment

- 1) Open all input and output terminals on the unit.
- 2) Connect a digital voltmeter between the + and - terminals of TP-1 for the L channel or between the + and - terminals of TP-2 for the R channel.
- 3) Adjust R729 (channel L) or R730 (channel R) so that the voltmeter reads 7 mV about 1 minute after the power has been turned on. (Note that the idling current is about 20 mA after the unit has warmed up.)

10. VOLTAGE CONVERSION

• EUROPEAN MODEL ONLY

To convert the unit to a different power source voltage, change the position as illustrated in the drawing below.

CAUTION
DISCONNECT POWER SUPPLY CORD FROM AC
OUTLET BEFORE CONVERTING VOLTAGE.

Voltage Conversion Chart

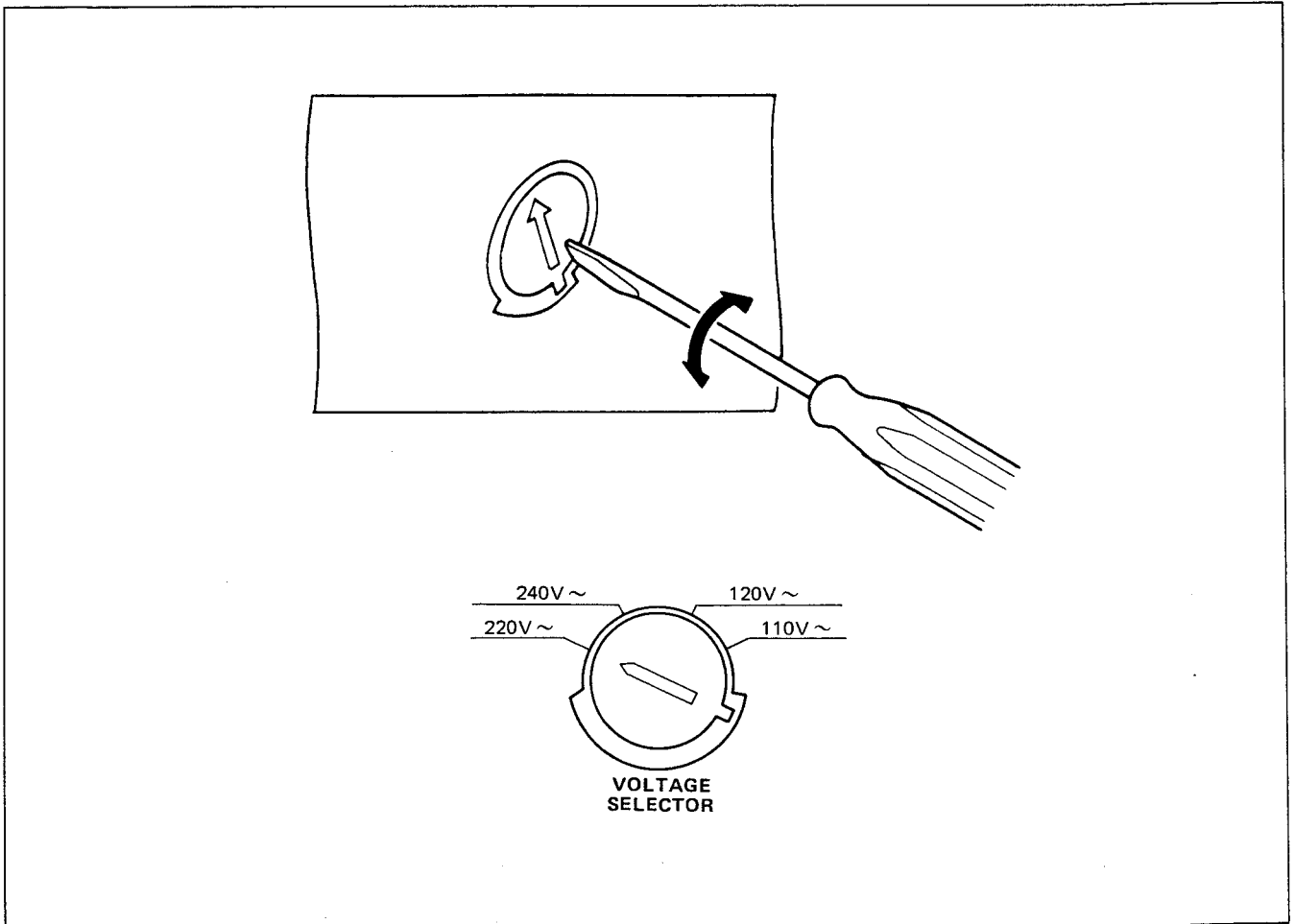

Note on safety: Symbol \triangle Fire or electrical shock hazard. Only original parts should be used to replace any part marked with symbol \triangle . Any other component substitution (other than original type), may increase risk of fire or electrical shock hazard.

11. BLOCK DIAGRAM

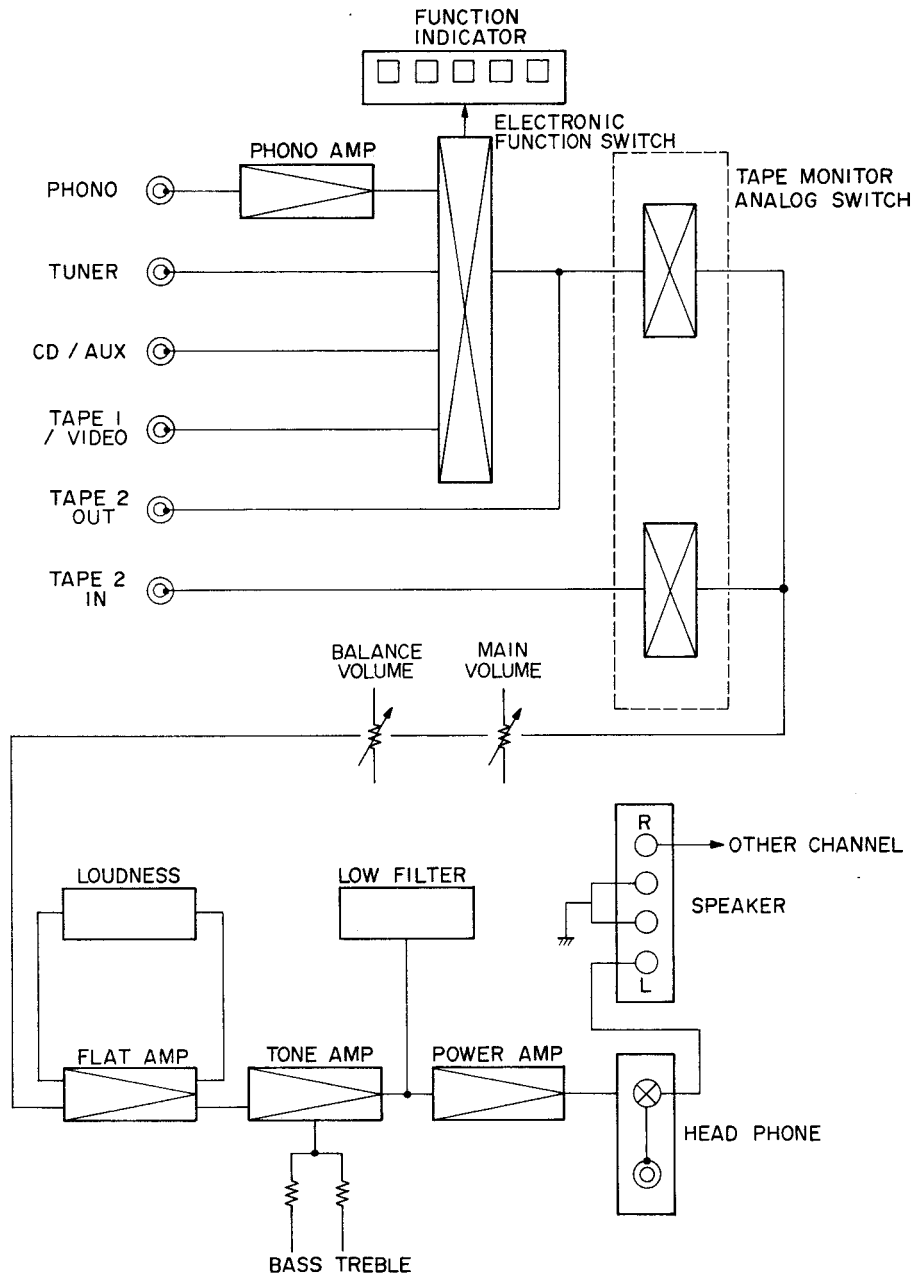

12.3 Main Assembly (P700) Schematic Diagram and Component Locations

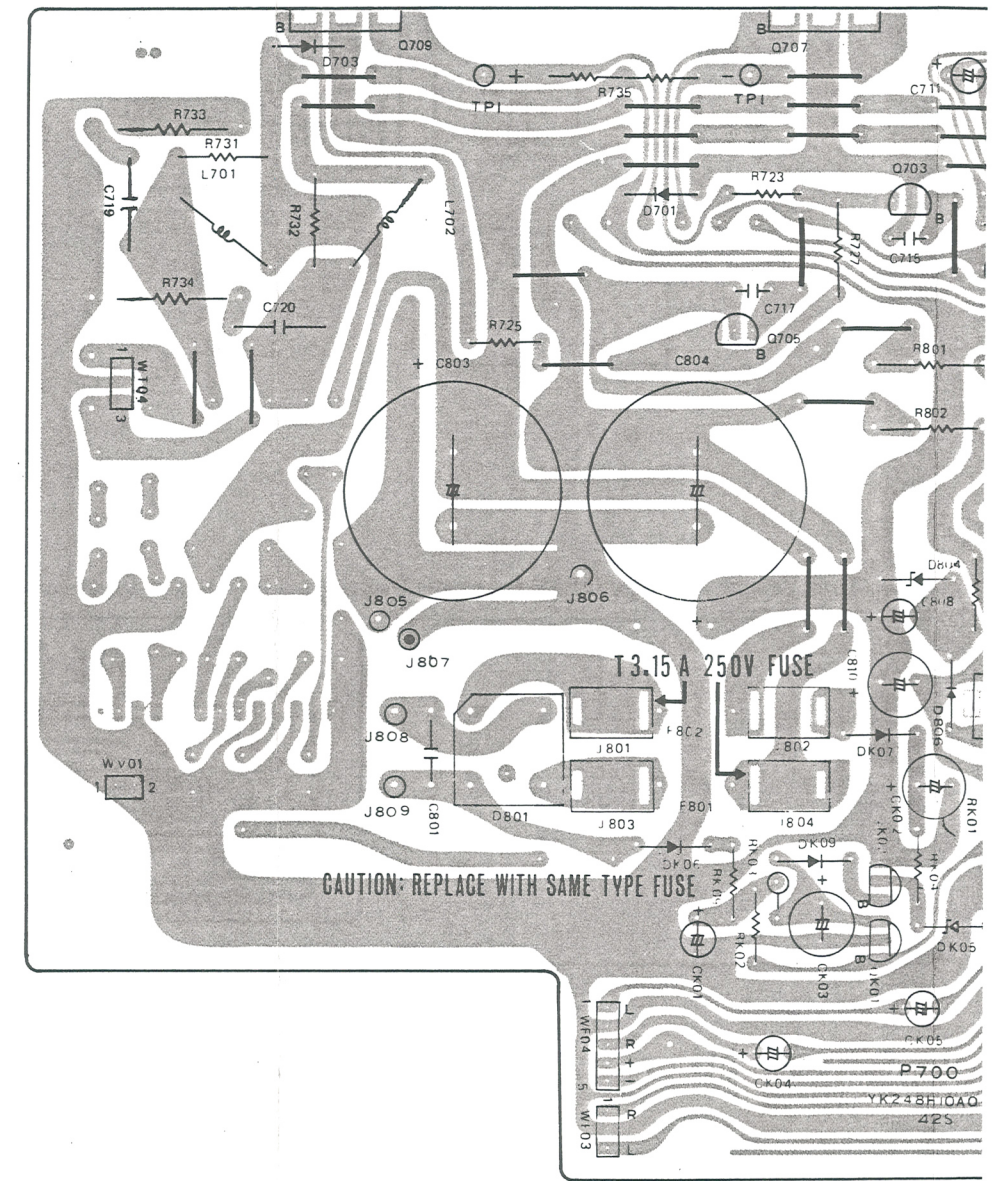
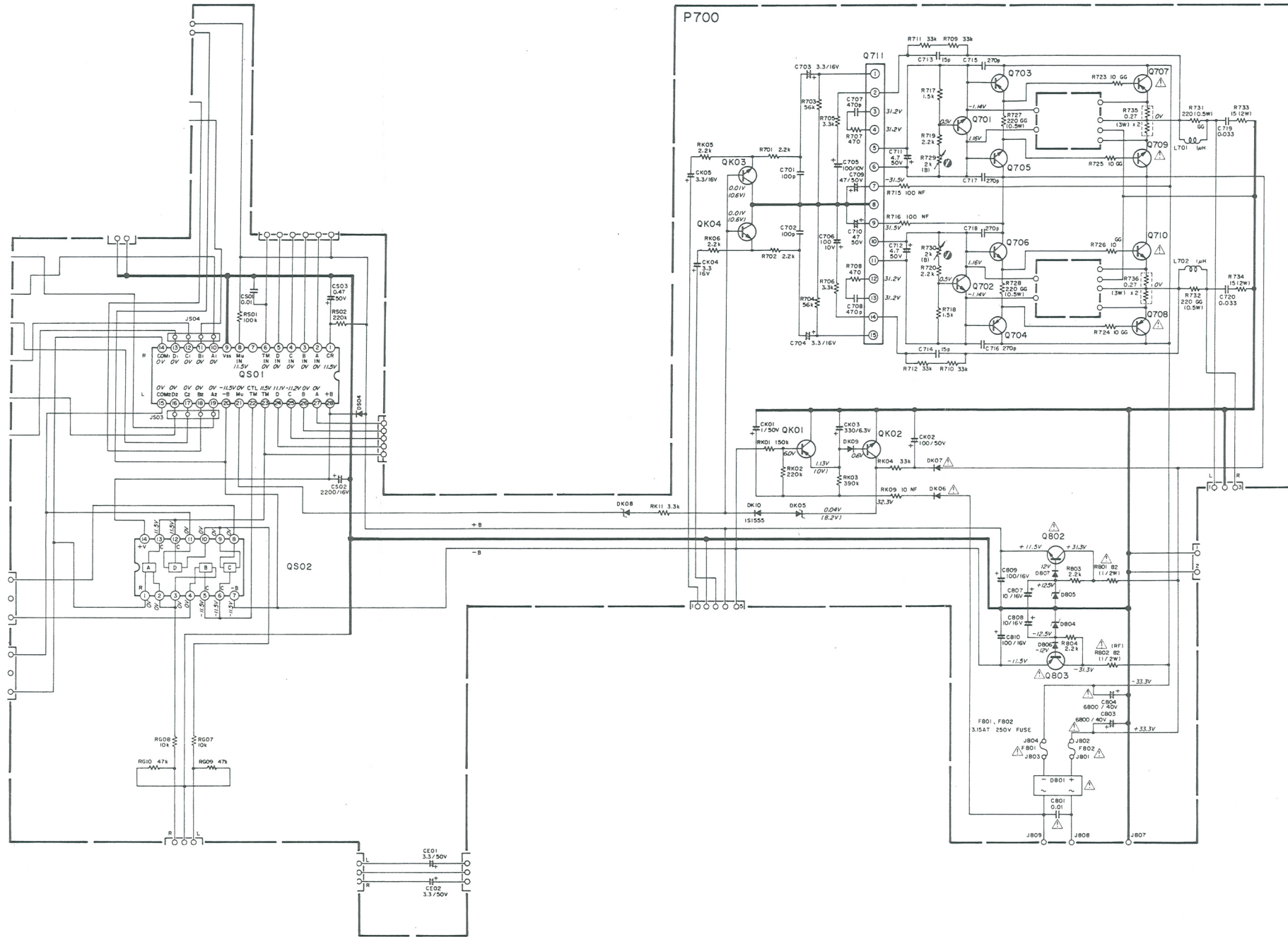

12.4 Main Volume Assembly (PS02) Schematic Diagram and Component Locations

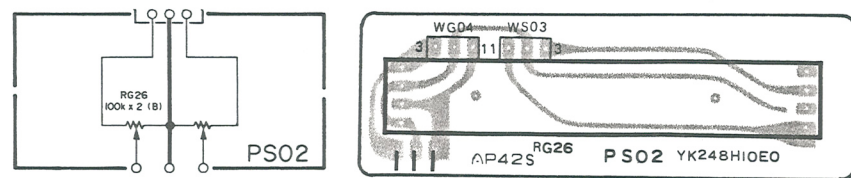

12.5 Balance Volume Assembly (PG02) Schematic Diagram and Component Locations

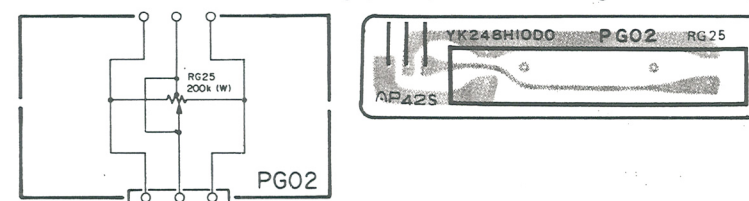

12.6 Power Switch Assembly (P001) Schematic Diagram and Component Locations

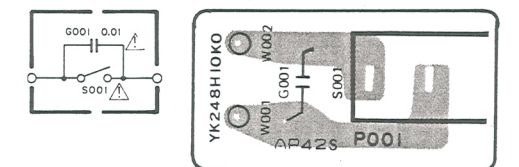

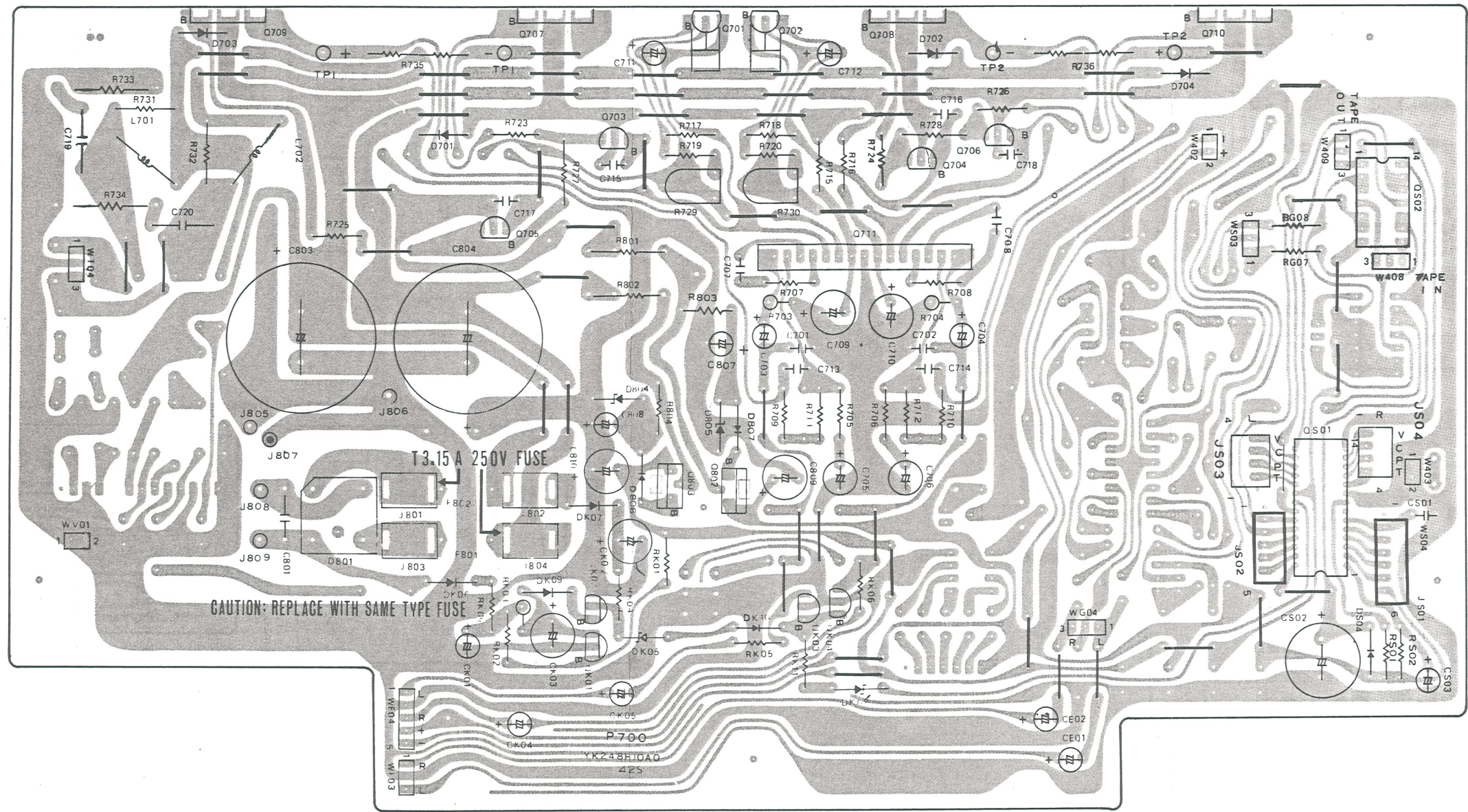
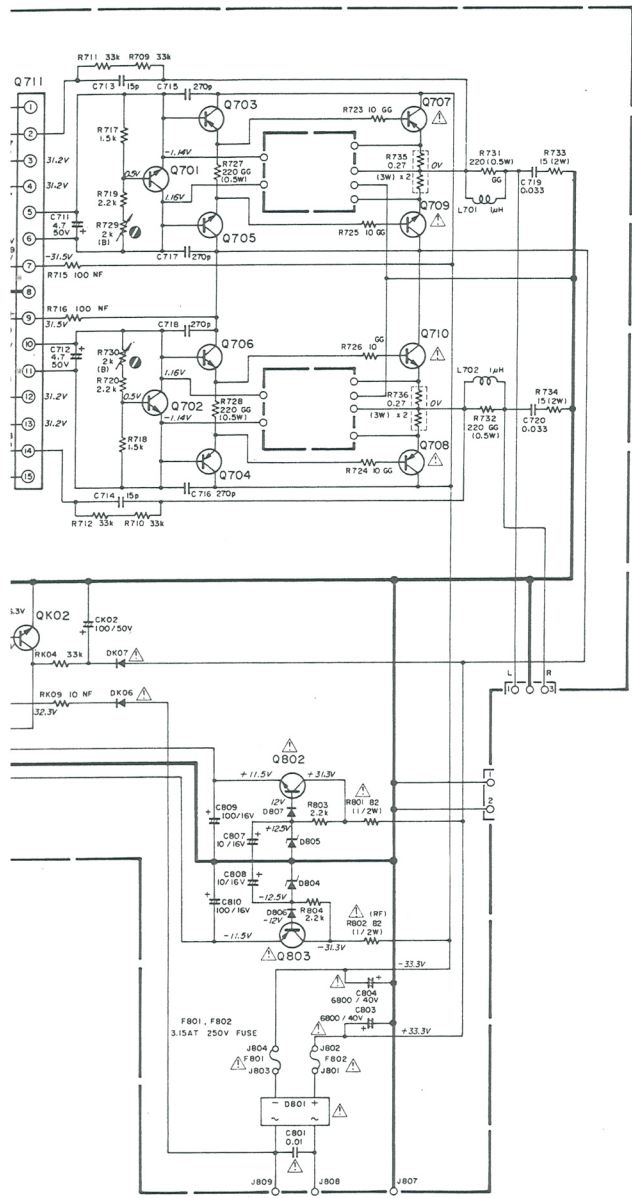

Volume Assembly (PG02) Schematic Diagram and Component Locations

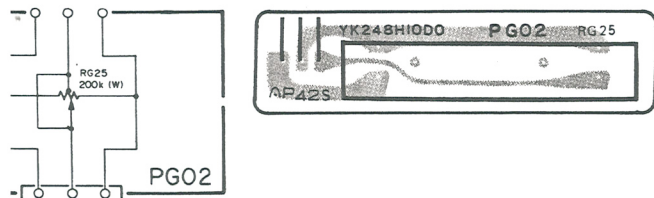

12.6 Power Switch Assembly (PO01) Schematic Diagram and Component Locations

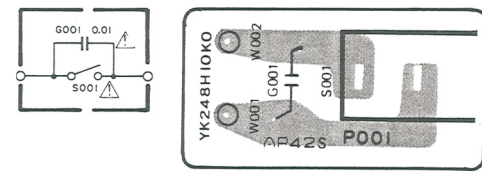

12.7 Speaker Terminal Assembly (PV00) Schematic Diagram and Component Locations

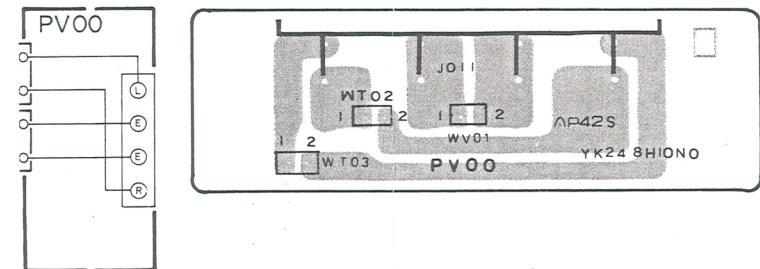

12.8 Tone Amp. Assembly (PE00) Schematic Diagram and Component Locations

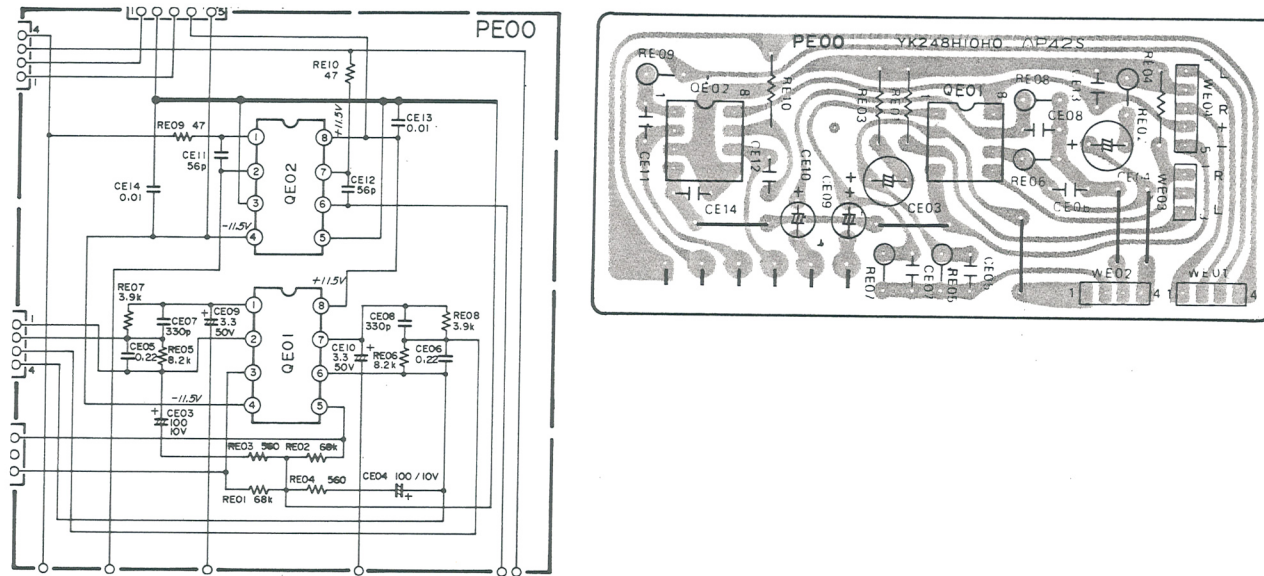

12.10 Low Filter Loud. Assembly (PE02) Schematic Diagram and Component Locations

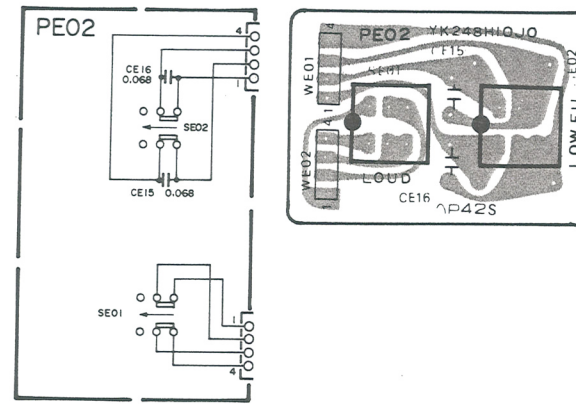

13. EXPLODED

• [C01-99] Fr

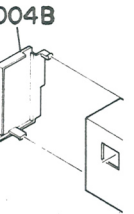

12.11 Tone Volume Assembly (PE01) Schematic Diagram and Component Locations

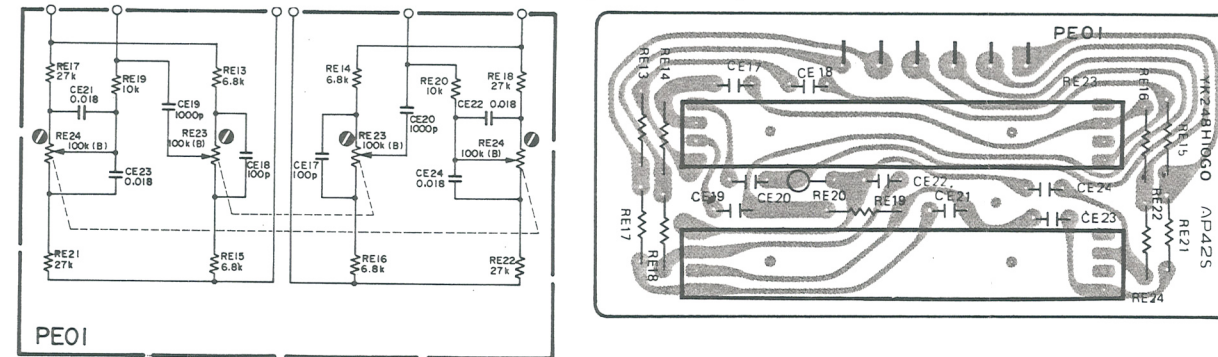

12.9 Function Assembly (PX00) Schematic Diagram and Component Locations

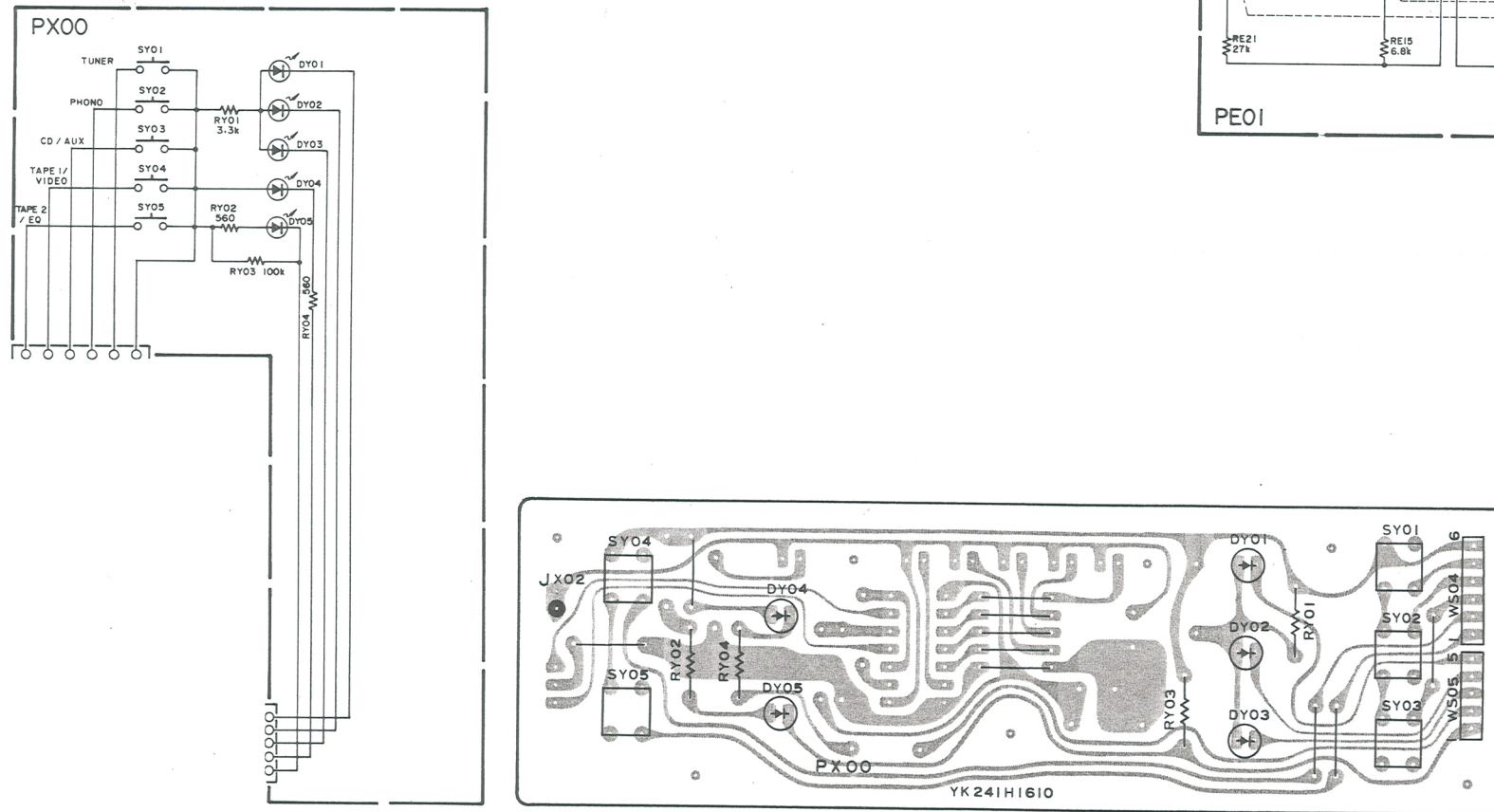

12.12 Tone Amp./Volume Control Assembly (PE03) Schematic Diagram and Component Locations

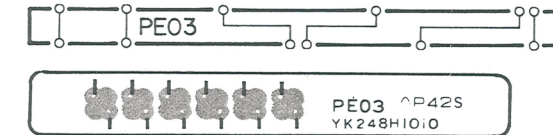

REF. DESIG.	Q'TY	PAR
	N	A
A	1	1 248H0
002B	1	1 248H0
003B	1	1 415H0
004B	1	1 415H0
008B	1	1 415H2
009B	2	2 241H2
010B	1	1 241H2
011B	1	1 241H2
012B	1	1 248H2
013B	1	1 241H2
015B	1	1 248H1
020B	2	2 416H1
021B	3	3 420H1
022B	5	5 416H1
005B	2	2 51280:
006B	2	2 51280:
019B	3	3 141T1
023B	1	1 248H1

12.10 Low Filter Loud. Assembly (PE02) Schematic Diagram and Component Locations

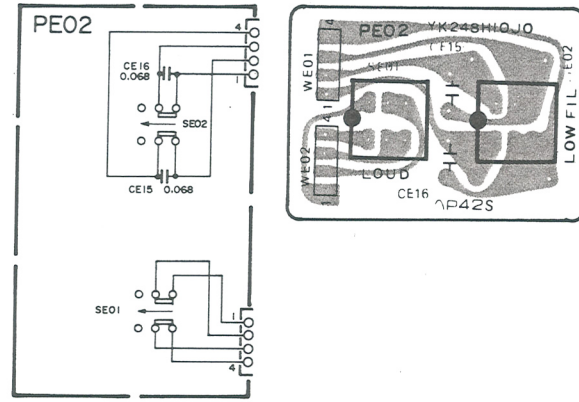

12.11 Tone Volume Assembly (PE01) Schematic Diagram and Component Locations

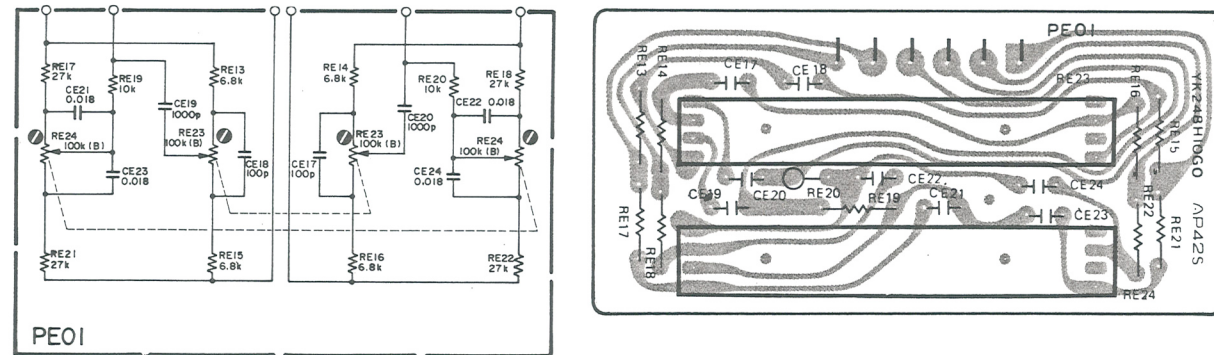

12.12 Tone Amp./Volume Control Assembly (PE03) Schematic Diagram and Component Locations

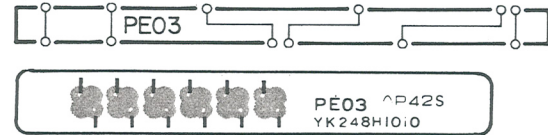

13. EXPLODED VIEW AND PARTS LIST

• [C01-99] Front Panel / Rear Panel

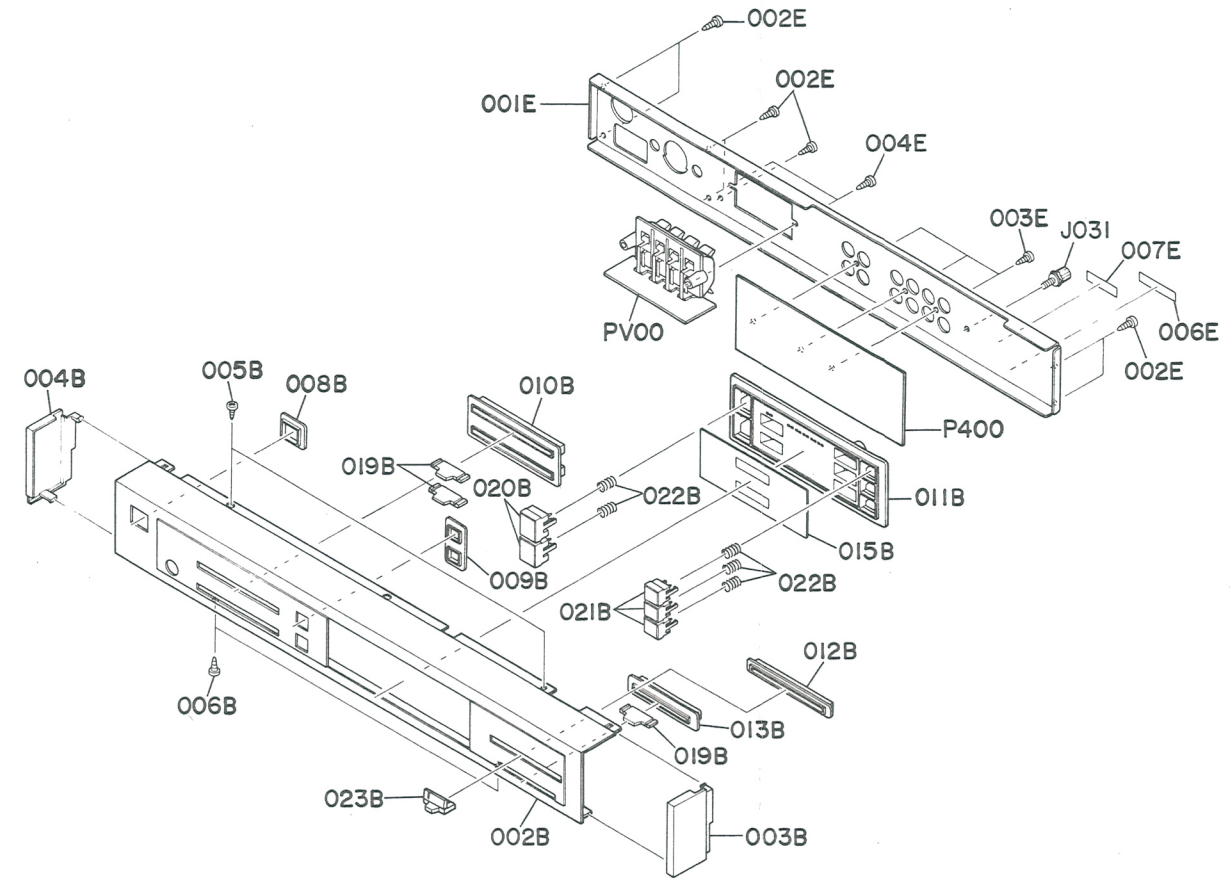

•(N):for Europe
•(A):for Australia

REF. DESIG.	QTY	PART NO.	DESCRIPTION	REF. DESIG.	QTY	PART NO.	DESCRIPTION	
	N	A			N	A		
A	1	1	248H063400	Front Panel Assembly	001E	1	248H160220	Bracket, Rear Panel
002B	1	1	248H063010	Escutcheon, Front Panel	002E	7	51280308B0	B.H. Tapped Screw B3 x 8
003B	1	1	415H067210	Cap (R)	003E	3	51280308B0	B.H. Tapped Screw B3 x 8
004B	1	1	415H067220	Cap (L)	004E	2	51280308B0	B.H. Tapped Screw B3 x 8
008B	1	1	415H259210	Bushing, Power Switch	006E	1	2112265010	Indicator, Serial No.
009B	2	2	241H259050	Bushing, Push Switch	007E	1	4581861010	Label, Made in Japan
010B	1	1	241H259030	Bushing, Tone Control	J031	1	YL03010250	Terminal, GND
011B	1	1	241H259020	Bushing, Function Switch				
012B	1	1	248H259010	Bushing, Volume				
013B	1	1	241H259040	Bushing, Balance				
015B	1	1	248H158010	Window				
020B	2	2	416H154220	Knob, Tape1/Tape2				
021B	3	3	420H154210	Knob, Phone/Tuner/CD				
022B	5	5	416H115010	Spring, Function Knob				
005B	2	2	51280308B0	B.H. Tapped Screw B3 x 8				
006B	2	2	51280308B0	B.H. Tapped Screw B3 x 8				
019B	3	3	141T154050	Knob, Tone Cont./Balance				
023B	1	1	248H154010	Knob, Volume				

• [C02-99] Lid (Top/Bottom)

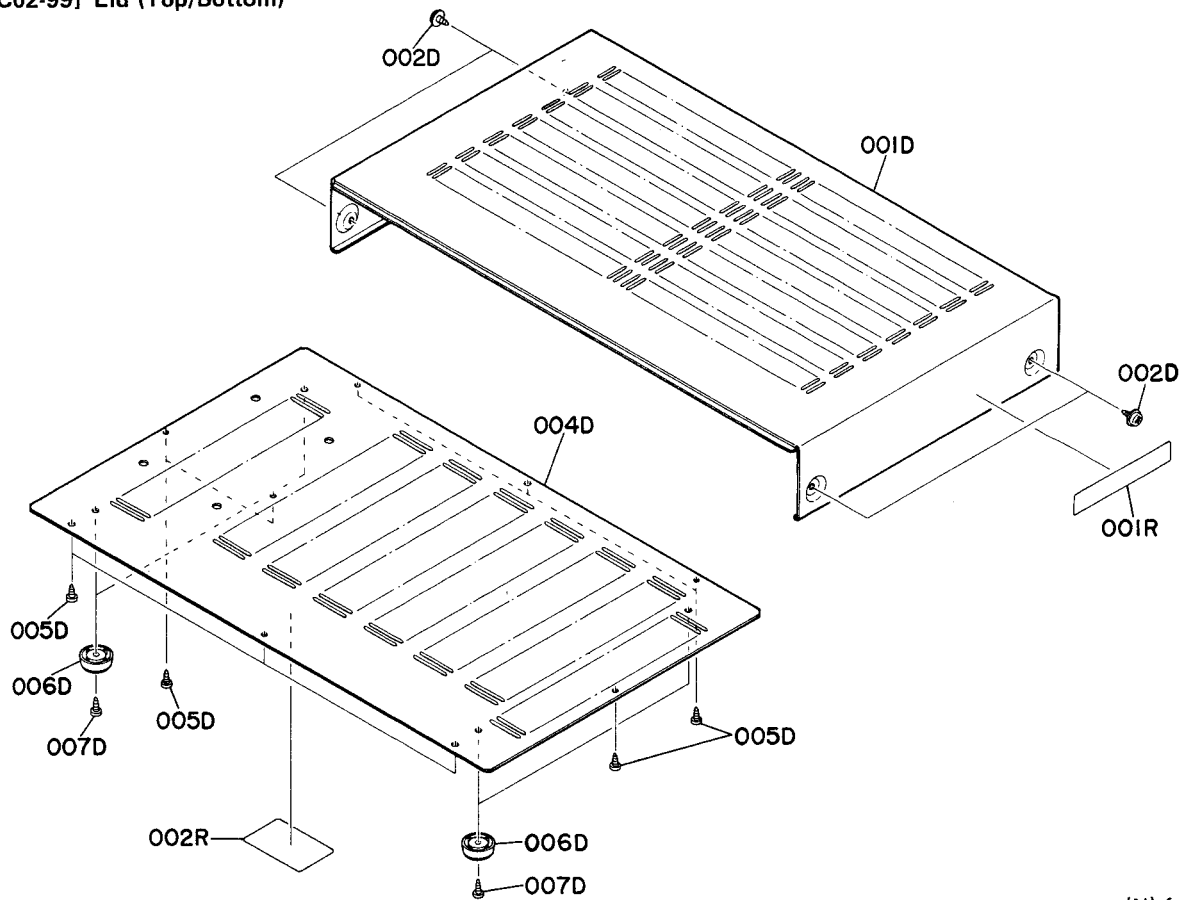

•(N):for Europe
•(A):for Australia

REF. DESIG.	Q'TY		PART NO.	DESCRIPTION
	N	A		
001D	1	1	241H257010	Lid, Top Cover
002D	4	4	51260408U0	B.T. Screw B4 x 8
004D	1	1	241H257020	Lid, Bottom Cover
005D	9	9	51280308B0	B.H. Tapped Screw B3 x 8
006D	4	4	416H057010	Leg
007D	4	4	51280406U0	B.H. Tapped Screw B4 x 6

REF. DESIG.	Q'TY		PART NO.	DESCRIPTION
	N	A		
001R	1	1	2911861140	Label
002R	1	1	2911861110	Label

● [P01-99] Chassis and General Parts

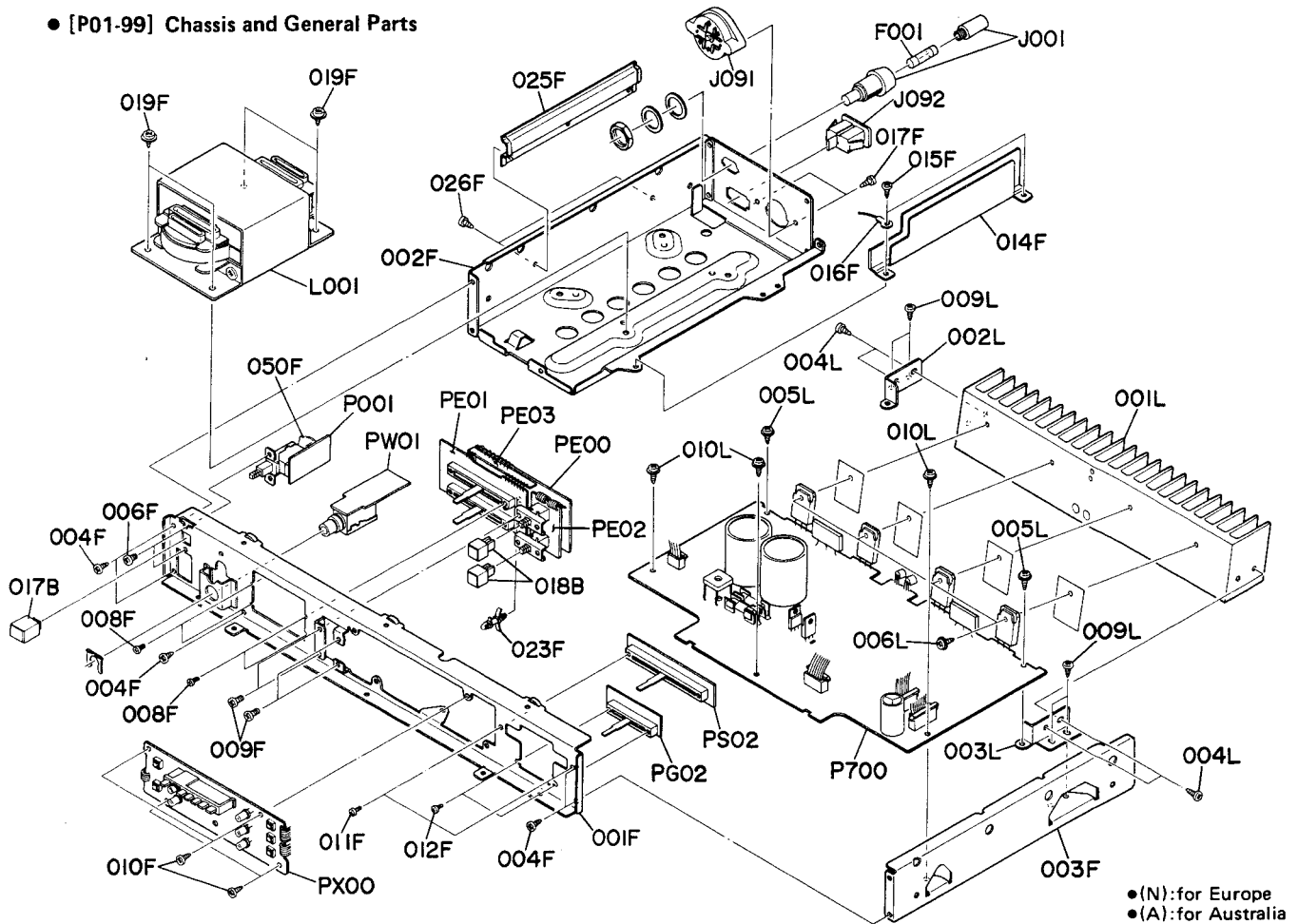

●(N):for Europe
●(A):for Australia

REF. DESIG.	Q'TY		PART NO.	DESCRIPTION
	N	A		
017B	1	1	415H154210	Knob, Power Switch
018B	2	2	241H154030	Knob, Push Switch
001F	1	1	248H160010	Bracket, Front Chassis
002F	1	1	241H160020	Bracket, Transformer
003F	1	1	241H160030	Bracket, Stay; (R)
004F	5	5	51280308B0	B.H. Tapped Screw B3 x 8
006F	2	2	51100306A9	B.H.M. Screw B3 x 6
008F	4	4	51100203A0	B.H.M. Screw B2 x 3
009F	4	4	51100306A9	B.H.M. Screw B3 x 6
010F	4	4	51280308B0	B.H. Tapped Screw B3 x 8
011F	2	2	51100203A0	B.H.M. Screw B2 x 3
012F	2	2	51100203A0	B.H.M. Screw B2 x 3
014F	1	1	240H109010	Shield
015F	2	2	51280308B0	B.H. Tapped Screw B3 x 8
016F	1	1	62030049W0	Lug
017F	2	2	51280308B0	B.H. Tapped Screw B3 x 8
019F	4	4	51260408U0	B.T. Screw B4 x 8
023F	1	1	240H101010	Support
025F	1	1	241H053010	Cover
026F	2	2	51280308B0	B.H. Tapped Screw B3 x 8
050F	1	1	139T120200	Insulator

REF. DESIG.	Q'TY		PART NO.	DESCRIPTION
	N	A		
001L	1	1	241H267110	Heatsink
002L	1	1	241H160060	Bracket, (L)
003L	1	1	241H160070	Bracket, (R)
004L	4	4	51280308B0	B.H. Tapped Screw B3 x 8
005L	2	2	51280308B0	B.H. Tapped Screw B3 x 8
006L	4	4	51260310B0	B.T. Screw B3 x 12
009L	4	4	51280308B0	B.H. Tapped Screw B3 x 8
010L	3	3	51260308B0	B.T. Screw B3 x 8
△ F001	1	1	FS10063800	Fuse, 630mAT 250V
△ J001	1	1	YJ08000290	Jack, Fuse Holder
△ J091	1	1	BY05080050	Voltage Selector
△ J092	1	1	YP04000580	Plug, AC Inlet
△ L001	1	1	TS17801070	Power Transformer

● [H01-99] Packing Materials

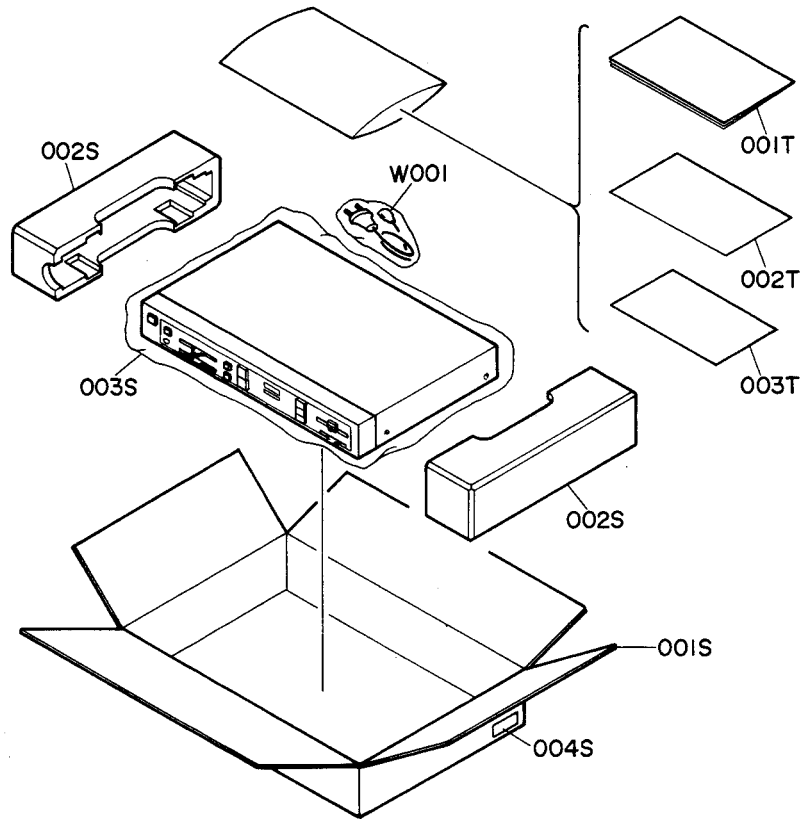

●(N):for Europe
●(A):for Australia

REF. DESIG.	QTY		PART NO.	DESCRIPTION
	N	A		
001S	1	1	248H801010	PACKING Packing Case
002S	2	2	241H809010	Cushion
003S	1	1	9090808030	Polyethylene Sheet
004S	4		9526019060	Serial No. Card
004S		4	9526019030	Serial No. Card
001T	1	1	241H851310	Instructions
002T	1	1	248H851320	Instructions, Spec
003T	1		248H856010	Circuit Diagram
003T		1	9631000090	Guarantee Card

REF. DESIG.	QTY		PART NO.	DESCRIPTION
	N	A		
△W001	1		ZC01805010	A.C. Power Cord
△W001		1	ZC02006020	A.C. Power Cord

14. ELECTRICAL PARTS LIST

•(N):for Europe
•(A):for Australia

REF. DESIG.	Q'TY		PART NO.	DESCRIPTION
	N	A		
P400	1	1	YK248H10B0	P400-PHONO INPUT CIRCUIT BOARD
	1	1	ZZ248H80B0	P.W. Board, Phono Input P.W. Board Assembly
P400-CAPACITORS				
CV01	1	1	EJ33502510	Elect 3.3 μ F 25V
CV02	1	1	EJ33502510	Elect 3.3 μ F 25V
CV03	1	1	EJ33502510	Elect 3.3 μ F 25V
CV04	1	1	EJ33502510	Elect 3.3 μ F 25V
CV05	1	1	EJ33502510	Elect 3.3 μ F 25V
CV06	1	1	EJ33502510	Elect 3.3 μ F 25V
CV07	1	1	EJ33502510	Elect 3.3 μ F 25V
CV08	1	1	EJ33502510	Elect 3.3 μ F 25V
C401	1	1	EJ33502510	Elect 3.3 μ F 25V
C402	1	1	EJ33502510	Elect 3.3 μ F 25V
C403	1	1	DF15332310	Film 3300pF \pm 5%
C404	1	1	DF15332310	Film 3300pF \pm 5%
C405	1	1	DF15123310	Film 0.012 μ F \pm 5%
C406	1	1	DF15123310	Film 0.012 μ F \pm 5%
C409	1	1	EJ33502510	Elect 3.3 μ F 25V
C410	1	1	EJ33502510	Elect 3.3 μ F 25V
C411	1	1	EJ10700610	Elect 100 μ F 6.3V
C412	1	1	EJ10700610	Elect 100 μ F 6.3V
C413	1	1	EJ47601610	Elect 47 μ F 16V
C414	1	1	EJ47601610	Elect 47 μ F 16V
C415	1	1	DD15101370	Ceramic 100pF \pm 5%
C416	1	1	DD15101370	Ceramic 100pF \pm 5%
C417	1	1	DD15821370	Ceramic 820pF \pm 5%
C418	1	1	DD15821370	Ceramic 820pF \pm 5%
P400-RESISTORS (All Resistors are \pm 5% and $\frac{1}{4}$ W)				
RV01	1	1	GD05102140	1K Ω
RV02	1	1	GD05102140	1K Ω
RV03	1	1	GD05105140	1M Ω
RV04	1	1	GD05105140	1M Ω
RV05	1	1	GD05102140	1K Ω
RV06	1	1	GD05102140	1K Ω
RV07	1	1	GD05105140	1M Ω
RV08	1	1	GD05105140	1M Ω
RV09	1	1	GD05102140	1K Ω
RV10	1	1	GD05102140	1K Ω
RV11	1	1	GD05105140	1M Ω
RV12	1	1	GD05105140	1M Ω
RV15	1	1	GD05102140	1K Ω
RV16	1	1	GD05102140	1K Ω
RV17	1	1	GD05105140	1M Ω
RV18	1	1	GD05105140	1M Ω
RV19	1	1	GD05221140	220 Ω
RV20	1	1	GD05221140	220 Ω
R401	1	1	GD05154140	150K Ω
R402	1	1	GD05154140	150K Ω
R403	1	1	GD05683140	68K Ω
R404	1	1	GD05683140	68K Ω
R405	1	1	GD05222140	2.2K Ω
R406	1	1	GD05222140	2.2K Ω
R407	1	1	GD05223140	22K Ω
R408	1	1	GD05223140	22K Ω
R409	1	1	GD05274140	270K Ω
R410	1	1	GD05274140	270K Ω

REF. DESIG.	Q'TY		PART NO.	DESCRIPTION
	N	A		
R411	1	1	GD05471140	470 Ω
R412	1	1	GD05471140	470 Ω
R413	1	1	GD05103140	10K Ω
R414	1	1	GD05103140	10K Ω
R435	1	1	GG05101140	100 Ω
R436	1	1	GG05101140	100 Ω
P400-MISCELLANEOUS				
JV01	1	1	YT02040490	Terminal, (4P) RCA Jack
JV02	1	1	YT02040490	Terminal, (4P) RCA Jack
JV03	1	1	YT02040490	Terminal, (4P) RCA Jack
W401	1	1	YU03340260	Jumper Lead, (3P)
W402	1	1	YU02260260	Jumper Lead, (2P)
W403	1	1	YU02280260	Jumper Lead, (2P)
W404	?	1	YU03340260	Jumper Lead, (3P)
W406	1	1	YU03340260	Jumper Lead, (3P)
W408	1	1	YU03340260	Jumper Lead, (3P)
W409	1	1	YU03340260	Jumper Lead, (3P)
P700-MAIN CIRCUIT BOARD				
P700	1	1	YK248H10A0	P.W. Board, Main
	1	1	ZZ248H80A0	P.W. Board Assembly
P700-CAPACITORS				
CE01	1	1	EA33505030	Elect 3.3 μ F 50V
CE02	1	1	EA33505030	Elect 3.3 μ F 50V
CK01	1	1	EA10505030	Elect 1 μ F 50V
CK02	1	1	EA10705030	Elect 100 μ F 50V
CK03	1	1	EA33700630	Elect 330 μ F 6.3V
CK04	1	1	EA33501630	Elect 3.3 μ F 16V
CK05	1	1	EA33501630	Elect 3.3 μ F 16V
CS01	1	1	DK17103300	Ceramic 0.01 μ F \pm 20%
CS02	1	1	EA22801630	Elect 2200 μ F 16V
CS03	1	1	EA47405030	Elect 0.47 μ F 50V
C701	1	1	DK16101300	Ceramic 100pF \pm 10%
C702	1	1	DK16101300	Ceramic 100pF \pm 10%
C703	1	1	EA33505030	Elect 3.3 μ F 50V
C704	1	1	EA33505030	Elect 3.3 μ F 50V
C705	1	1	EA10701030	Elect 100 μ F 10V
C706	1	1	EA10701030	Elect 100 μ F 10V
C707	1	1	DD15471370	Ceramic 470pF \pm 5%
C708	1	1	DD15471370	Ceramic 470pF \pm 5%
C709	1	1	EA47605030	Elect 47 μ F 50V
C710	1	1	EA47605030	Elect 47 μ F 50V
C711	1	1	EA47505030	Elect 4.7 μ F 50V
C712	1	1	EA47505030	Elect 4.7 μ F 50V
C713	1	1	DD11150300	Ceramic 15pF \pm 0.5pF
C714	1	1	DD11150300	Ceramic 15pF \pm 0.5pF
C715	1	1	DK16271550	Ceramic 270pF \pm 10%
C716	1	1	DK16271550	Ceramic 270pF \pm 10%
C717	1	1	DK16271550	Ceramic 270pF \pm 10%
C718	1	1	DK16271550	Ceramic 270pF \pm 10%
C719	1	1	DF15333550	Film 0.033 μ F \pm 5%
C720	1	1	DF15333550	Film 0.033 μ F \pm 5%
△C801	1	1	DK18103510	Ceramic 0.01 μ F
△C803	1	1	EB68804070	Elect 6800 μ F 40V
△C804	1	1	EB68804070	Elect 6800 μ F 40V
C807	1	1	EA10601630	Elect 10 μ F 16V
C808	1	1	EA10601630	Elect 10 μ F 16V
C809	1	1	EA10701630	Elect 100 μ F 16V
C810	1	1	EA10701630	Elect 100 μ F 16V

•(N):for Europe
•(A):for Australia

REF. DESIG.	QTY		PART NO.	DESCRIPTION
	N	A		
P700-RESISTORS (All Resistors are $\pm 5\%$ and $\frac{1}{4}W$)				
RG07	1	1	GD05103140	10K Ω
RG08	1	1	GD05103140	10K Ω
RG09	1	1	GD05473140	47K Ω
RG10	1	1	GD05473140	47K Ω
RK01	1	1	GD05154140	150K Ω
RK02	1	1	GD05224140	220K Ω
RK03	1	1	GD05394140	390K Ω
RK04	1	1	GD05333140	33K Ω
RK05	1	1	GD05222140	2.2K Ω
RK06	1	1	GD05222140	2.2K Ω
RK09	1	1	GG05100140	10 Ω
RK11	1	1	GD05332140	3.3K Ω
RS01	1	1	GD05104140	100K Ω
RS02	1	1	GD05224140	220K Ω
R703	1	1	GD05563140	56K Ω
R704	1	1	GD05563140	56K Ω
R705	1	1	GD05332140	3.3K Ω
R706	1	1	GD05332140	3.3K Ω
R707	1	1	GD05471140	470 Ω
R708	1	1	GD05471140	470 Ω
R709	1	1	GD05333140	33K Ω
R710	1	1	GD05333140	33K Ω
R711	1	1	GD05333140	33K Ω
R712	1	1	GD05333140	33K Ω
R715	1	1	GG05101140	100 Ω
R716	1	1	GG05101140	100 Ω
R717	1	1	GD05152140	1.5K Ω
R718	1	1	GD05152140	1.5K Ω
R719	1	1	GD05222140	2.2K Ω
R720	1	1	GD05222140	2.2K Ω
R723	1	1	GG05100140	10 Ω
R724	1	1	GG05100140	10 Ω
R725	1	1	GG05100140	10 Ω
R726	1	1	GG05100140	10 Ω
R727	1	1	GG05221120	220 Ω $\frac{1}{2}W$
R728	1	1	GG05221120	220 Ω $\frac{1}{2}W$
R729	1	1	RA02020800	2K Ω (B), Trimming
R730	1	1	RA02020800	2K Ω (B), Trimming
R731	1	1	GG05221120	220 Ω $\frac{1}{2}W$
R732	1	1	GG05221120	220 Ω $\frac{1}{2}W$
R733	1	1	GA05150020	15 Ω 2W
R734	1	1	GA05150020	15 Ω 2W
R735	1	1	BW10000040	0.27 Ω x 2 3W, Compo.
R736	1	1	BW10000040	0.27 Ω x 2 3W, Compo.
△R801	1	1	RF05820120	82 Ω $\frac{1}{2}W$, Fusible
△R802	1	1	RF05820120	82 Ω $\frac{1}{2}W$, Fusible
R803	1	1	GD05222140	2.2K Ω
R804	1	1	GD05222140	2.2K Ω
P700-SEMICONDUCTORS				
DK05	1	1	HD30023090	Zener WZ071
△DK06	1	1	HD20015030	Diode DS135D
△DK07	1	1	HD20015030	Diode DS135D
DK08	1	1	HD30023010	Zener HZ6C1L
DK09	1	1	HD20001000	Diode 1S1555
DK10	1	1	HD20001000	Diode 1S1555

REF. DESIG.	QTY		PART NO.	DESCRIPTION
	N	A		
DS04	1	1	HD20001000	Diode 1S1555
D801	1	1	HD20008290	Diode S4VB20
D804	1	1	HD30038010	Zener HZ12A2L
D805	1	1	HD30009010	Zener HZ12A2L
D806	1	1	HD20002210	Diode 1S2472
D807	1	1	HD20002210	Diode 1S2472
QK01	1	1	HT111752B0	Transistor 2SA1175(JF, HF)
QK02	1	1	HT327852B0	Transistor 2SC2785(JF, HF)
QK03	1	1	HT413022B0	Transistor 2SD1302(S or T)
QK04	1	1	HT413022B0	Transistor 2SD1302(S or T)
QS01	1	1	HC10110030	IC LC7815H
QS02	1	1	HC40660030	IC LC4066B-H
Q701	1	1	HT309452B0	Transistor 2SC945(P or Q)
Q702	1	1	HT309452B0	Transistor 2SC945(P or Q)
Q703	1	1	HT206472F0	Transistor 2SB647(C or D)
Q704	1	1	HT206472F0	Transistor 2SB647(C or D)
Q705	1	1	HT406672F0	Transistor 2SD667(C or D)
Q706	1	1	HT406672F0	Transistor 2SD667(C or D)
△Q707	1	1	HT111032B0	Transistor 2SA1103(O or Y)
△Q708	1	1	HT111032B0	Transistor 2SA1103(O or Y)
△Q709	1	1	HT325782B0	Transistor 2SC2578(O or Y)
△Q710	1	1	HT325782B0	Transistor 2SC2578(O or Y)
Q711	1	1	HC10111030	IC STK3042A
△Q802	1	1	HT412652P0	Transistor 2SD1265(O or P)
△Q303	1	1	HT205072P0	Transistor 2SB507(D or E)
P700-MISCELLANEOUS				
△F801	1	1	FS10315800	Fuse 3.15AT 250V
△F802	1	1	FS10315800	Fuse 3.15AT 250V
JS01	1	1	YJ06002540	Jack, (6P)
JS02	1	1	YJ06002390	Jack, (5P)
J801	1	1	YJ08000270	Jack, Fuse Clip
J802	1	1	YJ08000270	Jack, Fuse Clip
J803	1	1	YJ08000270	Jack, Fuse Clip
J804	1	1	YJ08000270	Jack, Fuse Clip
L701	1	1	LL23905120	Coil, 1 μ H
L702	1	1	LL23905120	Coil, 1 μ H
WS03	1	1	YU03160260	Jumper Lead, (3P)
WS04	1	1	YU06120260	Jumper Lead, (6P)
WS05	1	1	YU05120260	Jumper Lead, (5P)

●(N):for Europe
●(A):for Australia

REF. DESIG.	Q'TY		PART NO.	DESCRIPTION
	N	A		
PE00	1	1	YK248H10HO	PE00-TONE AMP CIRCUIT BOARD P.W. Board, Tone Amp
	1	1	ZZ248H80HO	P.W. Board Assembly
PE00-CAPACITORS				
CE03	1	1	EA10701030	Elect 100 μ F 10V
CE04	1	1	EA10701030	Elect 100 μ F 10V
CE05	1	1	DF16224350	Film 0.22 μ F \pm 10%
CE06	1	1	DF16224350	Film 0.22 μ F \pm 10%
CE07	1	1	DK16331300	Ceramic 330pF \pm 10%
CE08	1	1	DK16331300	Ceramic 330pF \pm 10%
CE09	1	1	EA33505030	Elect 3.3 μ F 50V
CE10	1	1	EA33505030	Elect 3.3 μ F 50V
CE11	1	1	DD15560370	Ceramic 56pF \pm 5%
CE12	1	1	DD15560370	Ceramic 56pF \pm 5%
CE13	1	1	DK18103310	Ceramic 0.01 μ F
CE14	1	1	DK18103310	Ceramic 0.01 μ F
PE00-RESISTORS (All Resistors are \pm 5% and $\frac{1}{4}$ W)				
RE01	1	1	GD05683140	68K Ω
RE02	1	1	GD05683140	68K Ω
RE03	1	1	GD05561140	560 Ω
RE04	1	1	GD05561140	560 Ω
RE05	1	1	GD05822140	8.2K Ω
RE06	1	1	GD05822140	8.2K Ω
RE07	1	1	GD05392140	3.9K Ω
RE08	1	1	GD05392140	3.9K Ω
RE09	1	1	GD05470140	47 Ω
RE10	1	1	GD05470140	47 Ω
PE00-SEMICONDUCTORS				
QE01	1	1	HC10021090	IC NJM4560D-D
QE02	1	1	HC10003090	IC NJM4558D
PE00-MISCELLANEOUS				
WE01	1	1	YU04060260	Jumper Lead, (4P)
WE02	1	1	YU04060260	Jumper Lead, (4P)
WE03	1	1	YU03060260	Jumper Lead, (3P)
WE04	1	1	YU05060260	Jumper Lead, (5P)
PE01-TONE VOLUME CIRCUIT BOARD				
PE01	1	1	YK248H10G0	P.W. Board, Tone Volume
	1	1	ZZ248H80G0	P.W. Board Assembly
PE01-CAPACITORS				
CE17	1	1	DK16101300	Ceramic 100pF \pm 10%
CE18	1	1	DK16101300	Ceramic 100pF \pm 10%
CE19	1	1	DF15102300	Film 1000pF \pm 5%
CE20	1	1	DF15102300	Film 1000pF \pm 5%
CE21	1	1	DF16183300	Film 0.018 μ F \pm 5%
CE22	1	1	DF16183300	Film 0.018 μ F \pm 5%
CE23	1	1	DF16183300	Film 0.018 μ F \pm 5%
CE24	1	1	DF16183300	Film 0.018 μ F \pm 5%

REF. DESIG.	Q'TY		PART NO.	DESCRIPTION
	N	A		
PE01-RESISTORS (All Resistors are \pm 5% and $\frac{1}{4}$ W)				
RE13	1	1	GD05682140	6.8K Ω
RE14	1	1	GD05682140	6.8K Ω
RE15	1	1	GD05682140	6.8K Ω
RE16	1	1	GD05682140	6.8K Ω
RE17	1	1	GD05273140	27K Ω
RE18	1	1	GD05273140	27K Ω
RE19	1	1	GD05103140	10K Ω
RE20	1	1	GD05103140	10K Ω
RE21	1	1	GD05273140	27K Ω
RE22	1	1	GD05273140	27K Ω
RE23	1	1	RS01040230	100K Ω (B) x 2, Variable
RE24	1	1	RS01040230	100K Ω (B) x 2, Variable
PE02-LOW FILTER/LOUDNESS CIRCUIT BOARD				
PE02	1	1	YK248H10J0	P.W. Board, Low Filter/Loudness
	1	1	ZZ248H80J0	P.W. Board Assembly
CE15	1	1	DF15683350	Film Cap. 0.068 μ F \pm 5%
CE16	1	1	DF15683350	Film Cap. 0.068 μ F \pm 5%
SE01	1	1	SP02011020	Push Switch, Loudness
SE02	1	1	SP02011020	Push Switch, Low Filter
PE03-CONNECT CIRCUIT BOARD				
PE03	1	1	YK248H10I0	P.W. Board, Connect
PG02-BALANCE VOLUME CIRCUIT BOARD				
PG02	1	1	YK248H10D0	P.W. Board, Balance Volume
	1	1	ZZ248H80D0	P.W. Board Assembly
RG25	1	1	RX02040040	Variable Resistor 220K Ω (W)
WG04	1	1	YU03060260	Jumper Lead, (3P)
PS02-MAIN VOLUME CIRCUIT BOARD				
PS02	1	1	YK248H10E0	P.W. Board, Main Volume
	1	1	ZZ248H80E0	P.W. Board Assembly
RG26	1	1	RS01040240	Variable Resistor 100K Ω (B) x 2
PV00-SPEAKER TERMINAL CIRCUIT BOARD				
PV00	1	1	YK248H10N0	P.W. Board, Speaker Terminal
	1	1	ZZ248H80N0	P.W. Board Assembly
J011	1	1	YT03040230	Terminal, Speaker
WV01	1	1	YU02260240	Jumper Lead, (2P)

•(N):for Europe
•(A):for Australia

REF. DESIG.	Q'TY		PART NO.	DESCRIPTION
	N	A		
PW01	1	1	YK248H10P0	PW01-PHONE JACK CIRCUIT BOARD P.W. Board, Phone Jack P.W. Board Assembly
	1	1	ZZ248H80P0	
RW01	1	1	GA05331010	Resistor 330Ω ±5% 1W
RW02	1	1	GA05331010	Resistor 330Ω ±5% 1W
J051	1	1	YJ01001770	Jack, Headphone
WT02	1	1	YU02340240	Jumper Lead, (2P)
WT04	1	1	YU03280240	Jumper Lead, (3P)
PX00	1	1	YK241H1610	PX00-FUNCTION L.E.D. CIRCUIT BOARD P.W. Board, Function L.E.D. P.W. Board Assembly
	1	1	ZZ248H8610	
PX00-RESISTORS (All Resistors are ±5% and ¼W)				
RY01	1	1	GD05332140	3.3KΩ
RY02	1	1	GD05562140	560Ω
RY04	1	1	GD05561140	560Ω
RX00-SEMICONDUCTORS				
DY01	1	1	HI10017080	L.E.D. SEL1413E
DY02	1	1	HI10017080	L.E.D. SEL1423E
DY03	1	1	HI10017080	L.E.D. SEL1413E
DY04	1	1	HI10011080	L.E.D. SEL1213C
DY05	1	1	HI10011080	L.E.D. SEL1213C
PX00-SWITCHES				
SY01	1	1	SP01010570	Push Switch
SY02	1	1	SP01010570	Push Switch
SY03	1	1	SP01010570	Push Switch
SY04	1	1	SP01010570	Push Switch
SY05	1	1	SP01010570	Push Switch

REF. DESIG.	Q'TY		PART NO.	DESCRIPTION
	N	A		
P001	1	1	YK248H10K0	P001-POWER SWITCH CIRCUIT BOARD P.W. Board, Power Switch P.W. Board Assembly
	1	1	ZZ248H80K0	
△G001	1	1	DK18103850	Ceramic Cap. 0.01μF
△S001	1	1	SP01010650	Push Switch, Power

(W01-99)	Assembly and Wiring
(T01-99)	Adjustment
(X01-00)	Correction

NOTE ON SAFETY:

Symbol △ Fire or electrical shock hazard. Only original parts should be used to replace any part marked with symbol △. Any other component substitution (other than original type), may increase risk of fire or electrical shock hazard.

15. TECHNICAL SPECIFICATIONS

AUDIO SECTION

POWER OUTPUT PER CHANNEL

DIN 4 OHMS	33W
RMS 4 OHMS 1 kHz	33W
DIN 8 OHMS	30W
RMS 8 OHMS 1 kHz	30W
TOTAL HARMONIC DISTORTION AT RMS 8 OHMS	0.05%
I.M. DISTORTION 8 OHMS	0.05%
DAMPING FACTOR 8 OHMS (1 kHz)	50

MM CARTRIDGE INPUT

Frequency Response (RIAA) 20 Hz — 20 kHz	±0.5 dB
Signal-to-Noise Ratio	80 dB
Input Impedance	47k ohms
Input Capacitance	270 pF
Input Sensitivity	2.5 mV
Equivalent Input Noise	1.3 μ V

AUX. INPUT

Input Impedance	30k ohms
Input Sensitivity	150 mV
Frequency Response	10 Hz ~ 40 kHz
Signal-to-Noise Ratio	90 dB

OUTPUT VOLTAGE

Tape Out	460 mV
----------	--------

OUTPUT IMPEDANCE

Tape Out	290 ohms
----------	----------

GENERAL

Power Requirement	110/120/220/240V AC, 50/60 Hz
Power Consumption at Rated Output, both Channels Driven	120W
Dimensions	
Panel Width	416 mm
Panel Height	55 mm
Depth	260 mm
Weight	
Unit Alone	4.8 kg

Specifications and appearance are subject to change for modification without notice.

16. SCHEMATIC DIAGRAM

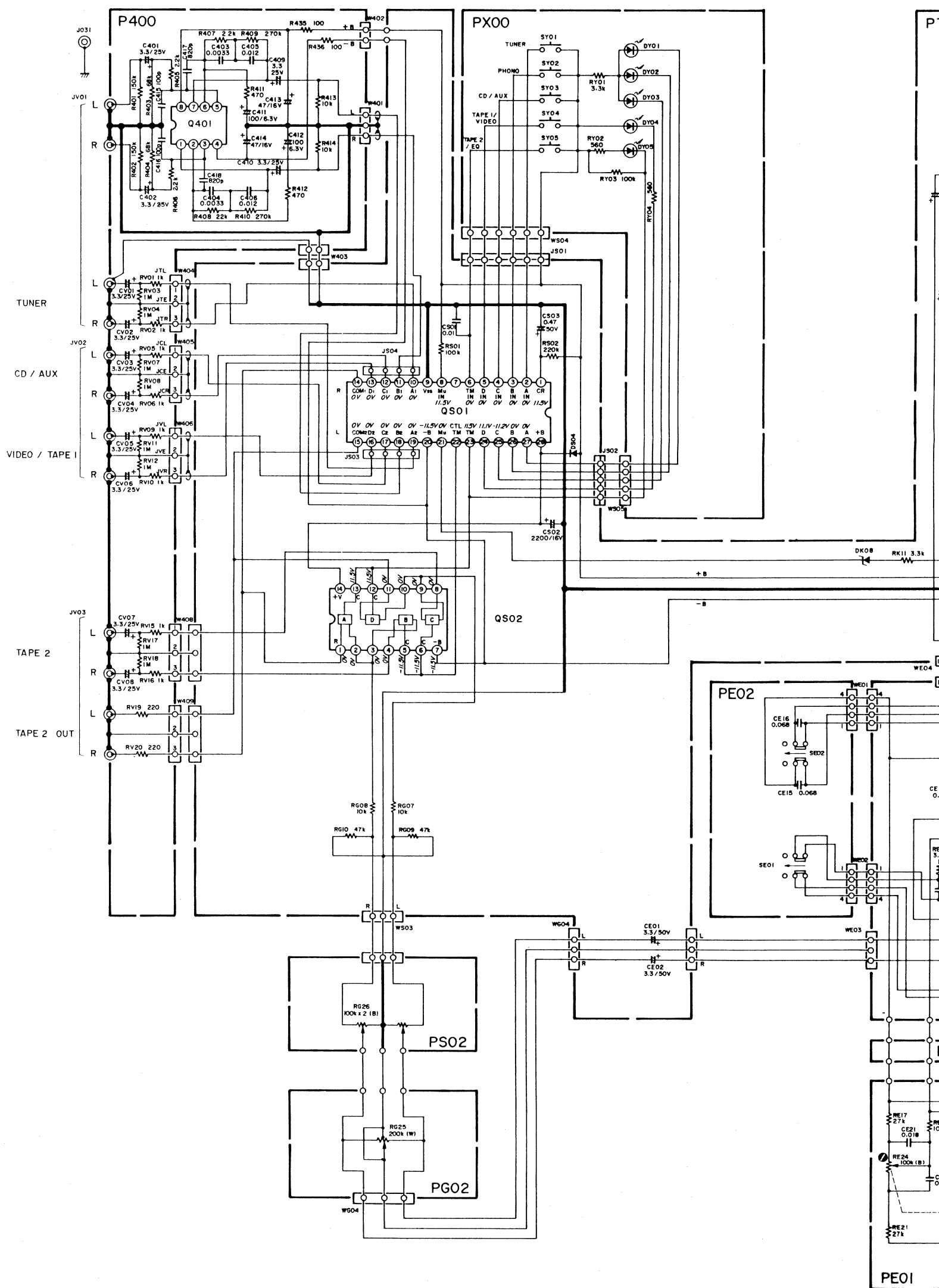

NOTE ON SAFETY :
 Symbol \triangle Fire or electrical shock hazard. Only original parts should be used to replace any part marked with symbol \triangle . Any other component substitution (other than original type), may increase risk of fire or electrical shock hazard.

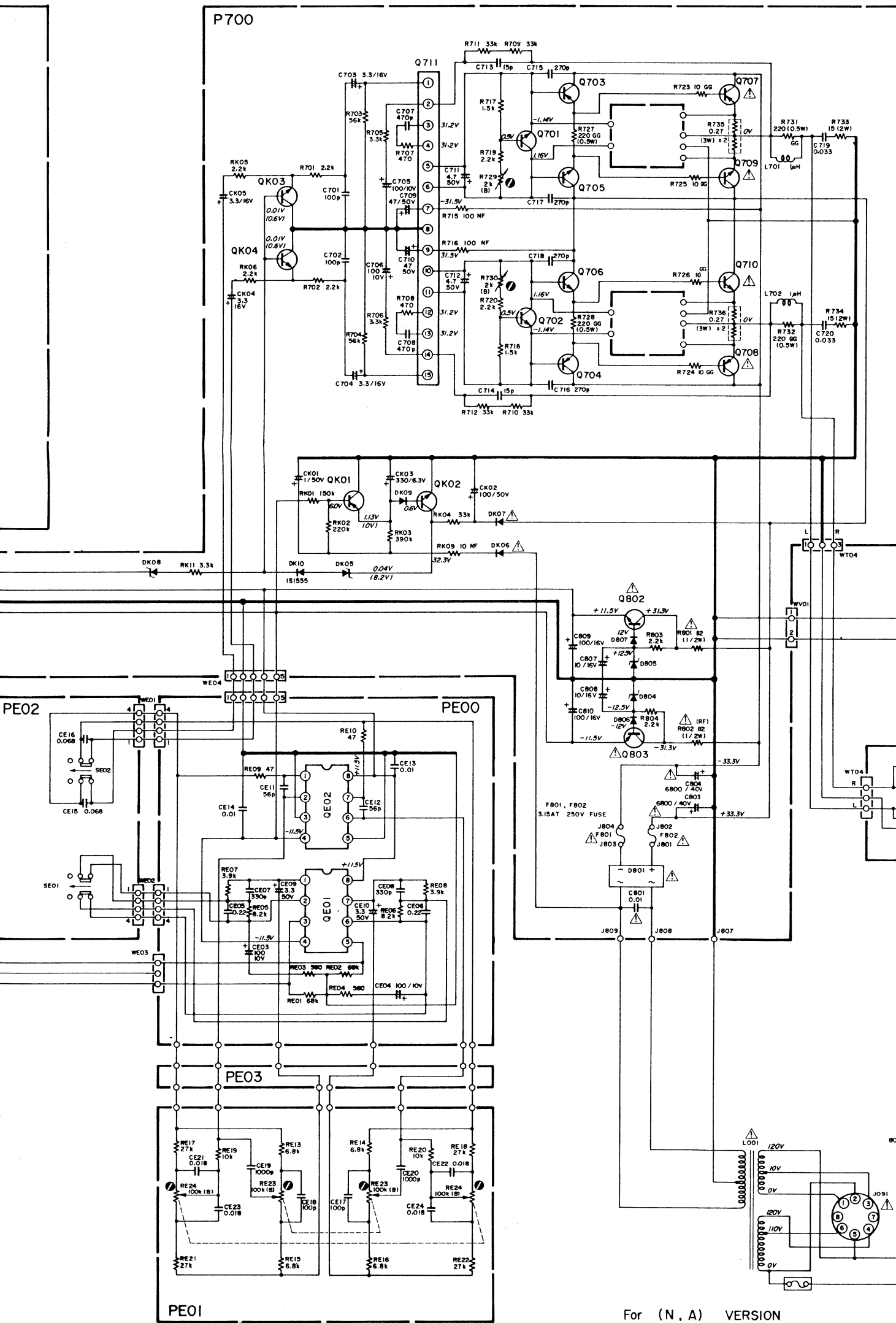

QK01 HT111752B1 2SA1175 (J or H)		
QK02 HT327852B1 2SC2785 (J or H)	Q802 HT412652A0 2SD1265 (O, P)	DS04 HD20001001 IS1555
QK03, QK04 HT413022B1 2SD1302 (S, T)	Q803 HT205072P0 2SB507 (D, E)	DK05 HD30023090 WZ071
Q701, Q702 HT309452B0 2SC945 (P, Q)	QS01 HC10110030 LC7815H	DK06, DK07 HD20015030 DS135D
Q703, Q704 HT206472F0 2SB647 (C, D)	QS02, HC406603C0 LC4066B - H	DK08 HD30023011 HZ6CIL
Q705, Q706 HT406672F0 2SD667 (C, D)	QE01 HC10021090 NJM4560D - D	DK09, DK10 HD20001001 IS1555
Q707, Q708 HT11032B0 2SA1103 (O, Y)	QE02 HC1003090 NJM4558D	D801 HD20008290 S4VB20
Q709, Q710 HT325782B0 2SC2578 (O, Y)	DY01 ~ DY03 H110017080 SEL1413E	D804, D805 HD30009011 HZ12A2L
Q711 HC1011030 STK3042A	DY04, DY05 H110011080 SEL1213C	D806, D807 HD20002210 IS2472 (GREEN)

For (N, A) VERSION

Components and wiring are subject to change for modification without notice.